

# Engine Monitoring Unit

Version 2.38



<b>1</b>	<b>Important Notices</b>	<b>3</b>
1.1	Limited Warranty	3
1.2	Packing Lists	4
<b>2</b>	<b>Technical Data</b>	<b>5</b>
2.1	General specifications	5
2.2	NMEA2000 specifications	5
2.3	Inputs	6
2.3.1	Analog inputs 1-5	6
2.3.2	Tach inputs (marked Frequency input 1-2)	7
2.4	Outputs	7
2.5	Accuracy	8
<b>3</b>	<b>Engine monitor connectors</b>	<b>9</b>
3.1	NMEA2000 M12 connector pinout	9
3.2	Sensor connectors pinout	10
3.3	Connector kit	11
3.4	Crimping and inserting wires	12
3.5	Examples for sensor connections	15
3.5.1	Resistive type sensors	15
3.5.2	Voltage type sensors with reference	15
3.5.3	Voltage output type sensors	16
3.5.4	Voltage output type sensors with external power supply	17
3.5.5	Current type output sensors	17
3.5.6	Anchor sensor	18
3.5.7	Digital inputs	18
3.5.8	RPM	18
3.5.8.1	Legacy Marine Engines	19
3.5.8.2	More Exotic RPM sensing	21
<b>4</b>	<b>Configuring EMU</b>	<b>24</b>
4.1.1	Configuration via WiFi	24
4.1.1.1	Home	24
4.1.1.2	Config	24
4.1.1.3	Info	26
4.1.2	Firmware update	26
4.1.2.1	Firmware update over NMEA2000 network	26
4.1.2.2	Firmware update using WiFi	26
<b>5</b>	<b>Supported data</b>	<b>28</b>
<b>6</b>	<b>Revision history</b>	<b>29</b>

# 1 Important Notices

Information in this document is subject to change without notice. LXNAV reserves the right to change or improve their products and to make changes in the content of this material without obligation to notify any person or organization of such changes or improvements.



A Yellow triangle is shown for parts of the manual which should be read very carefully and are important when operating the E500/E700.



Notes with a red triangle describe procedures which are critical and may result in loss of data or any other critical situation.



A bulb icon is shown when a useful hint is provided to the reader.

## 1.1 Limited Warranty

This Engine Monitoring Unit product is warranted to be free from defects in materials or workmanship for two years from the date of purchase. Within this period, LXNAV will, at its sole option, repair or replace any components that fail in normal use. Such repairs or replacement will be made at no charge to the customer for parts and labour, provided that the customer pays for shipping costs. This warranty does not cover failures due to abuse, misuse, accident, or unauthorized alterations or repairs.

THE WARRANTIES AND REMEDIES CONTAINED HEREIN ARE EXCLUSIVE AND IN LIEU OF ALL OTHER WARRANTIES EXPRESSED OR IMPLIED OR STATUTORY, INCLUDING ANY LIABILITY ARISING UNDER ANY WARRANTY OF MERCHANTABILITY OR FITNESS FOR A PARTICULAR PURPOSE, STATUTORY OR OTHERWISE. THIS WARRANTY GIVES YOU SPECIFIC LEGAL RIGHTS, WHICH MAY VARY FROM STATE TO STATE.



IN NO EVENT SHALL LXNAV BE LIABLE FOR ANY INCIDENTAL, SPECIAL, INDIRECT OR CONSEQUENTIAL DAMAGES, WHETHER RESULTING FROM THE USE, MISUSE, OR INABILITY TO USE THIS PRODUCT OR FROM DEFECTS IN THE PRODUCT.

Some states do not allow the exclusion of incidental or consequential damages, so the above limitations may not apply to you. LXNAV retains the exclusive right to repair or replace the unit or software, or to offer a full refund of the purchase price, at its sole discretion. SUCH REMEDY SHALL BE YOUR SOLE AND EXCLUSIVE REMEDY FOR ANY BREACH OF WARRANTY.

To obtain warranty service, contact your local LXNAV dealer or contact LXNAV directly.

## 1.2 Packing Lists

- Engine monitoring unit
- Installation manual
- Female connector kit
- Male connector kit
- 33k $\Omega$ , 68k $\Omega$ , and 100k $\Omega$  resistors for adjusting RPM signal level.

33k $\Omega$	68k $\Omega$	100k $\Omega$
		

## 2 Technical Data

### 2.1 General specifications

Parameter	Condition	Min	Typ	Max	Unit
Operating supply voltage <sup>(1)</sup>		8	12	32	V
Absolute maximum supply voltage <sup>(2)</sup>	Non-operating	-50		36	V
Current consumption <sup>(1)</sup>	WiFi Enabled		100		mA
Load equivalent number	WiFi Enabled	2			LEN
Isolation between NMEA 2000 and engine network			1kV		V <sub>rms</sub>
Supply protection		-50V			V
Operating temperature		-20		+65	°C
Storage temperature		-40		+85	°C
Recommended humidity		0		95	RH
Weight		115			g
Housing length		95			mm
Housing diameter		24			mm
Ingress Protection		TBD			

Note1: Supplied via M12 NMEA2000 connector

Note2: Non-operational, voltages outside of this range may permanently damage the device

**Table1: General specifications**

### 2.2 NMEA2000 specifications

Parameter	description
Compatibility	NMEA2000 compatible
Baudrate	250kbps
Connection	A coded M12 connector

Note1: Supplied via M12 NMEA2000 connector

**Table2: General specifications**

## 2.3 Inputs

### 2.3.1 Analog inputs 1-5

Engine monitoring unit features 5 fully configurable analogue inputs for:

- Voltage sensors: 0-5V
- Resistive: European, ABYC (US) and Asian standards
- Current output sensor 4-20mA (external resistor required)
- Digital input (Engine alarm input)

Reference connections for each of them are shown in chapter *3.5 Examples for sensor connections*. All of the analogue inputs have an internal switchable pullup resistor to 5V, thereby relieving the user of manual resistor installation.

Parameter	Condition	Min	Typ	Max	Unit
Input resistance	0V < Vin < 30V Pullup disabled	0.9	1.0	1.1	MΩ
Input capacitance	0V < Vin < 30V Pullup disabled	0.9	1.0	1.1	nF
Operating input range		0		18	V
Absolute maximum input voltage <sup>(1)</sup>		-36		36	V
Alarm input, logical HI state		4.5		18	V
Alarm input, logical LO state		0		3.0	V
Internal pullup resistance	Pullup enabled		500		Ω
Internal pullup voltage	Pullup enabled	TBD		TBD	V

Note 1: Continuously applied voltage. Voltage outside of this range may permanently damage the device

**Table 3: Analog input electrical characteristics**

### 2.3.2 Tach inputs (marked Frequency input 1-2)

Engine monitoring unit features 2 configurable tachometer inputs for RPM or Fuel Flow measurement. It can be configured as well as engine alarm input (Binary).



In case of Alarm input configuration, switch in this configuration needs external pull up resistor to 5V or 12V. Reference wiring diagram is same as for regular digital input.

Parameter	Condition	Min	Typ	Max	Unit
Input resistance	$0V < V_{in} < 30V$	20	50	52	$k\Omega$
Input capacitance	$1V < V_{in} < 30V$	90	100	200	pF
Absolute maximum input <sup>(1)</sup>		-75		40	V
Rising threshold			3.5		V
Falling threshold			2		V
Frequency range	$V_{in} = 5V_{AC}$			50	kHz

Note 1: Continuously applied voltage. Voltage outside of this range may permanently damage the device

**Table 4: Tach inputs electrical characteristics**

## 2.4 Outputs

Engine monitor unit also features one switchable 5V supply outputs for powering various sensors. The output has automatic resettable fuse protection against overcurrent, overvoltage and short-circuit faults.

Parameter	Condition	Min	Typ	Max	Unit
Power output voltage	$0 < I_{load} < 50mA$	4.9	5	5.15	V
Power output current	$V_{out} > 4.9V$	0		50	mA
Short circuit current limit	$V_{out} = 0V$	50	85	130	mA
Maximum overload voltage <sup>(1)</sup>		-25		40	V

Note 1: Voltage forced back into the 5V output pin. Voltage outside of this range may permanently damage the device

**Table 5: Power output electrical characteristics**

## 2.5 Accuracy

Shown accuracy limits represent the edges of the acceptable accuracy windows for the above specified operating conditions, typical values may be lower.

Parameter	Condition	Value
Voltage Input Accuracy	$0V < V_{in} < 18V$	1% of reading + 10mV TBD
Resistive Input Accuracy	$0\Omega < R_{in} < 1K\Omega$	1% of reading + 3 $\Omega$ TBD
	$1K\Omega < R_{in} < 5K\Omega$	10% of reading + 100 $\Omega$ TBD
Frequency Input Accuracy	$1Hz < f_{in} < 1KHz$	1% of reading + 2 Hz TBD
Voltage Input ADC Resolution		4.5 mV
Resistive Input Resolution		TBD
Frequency Input Resolution		0.05Hz

**Table 6: Accuracy specifications**



### 3 Engine monitor connectors

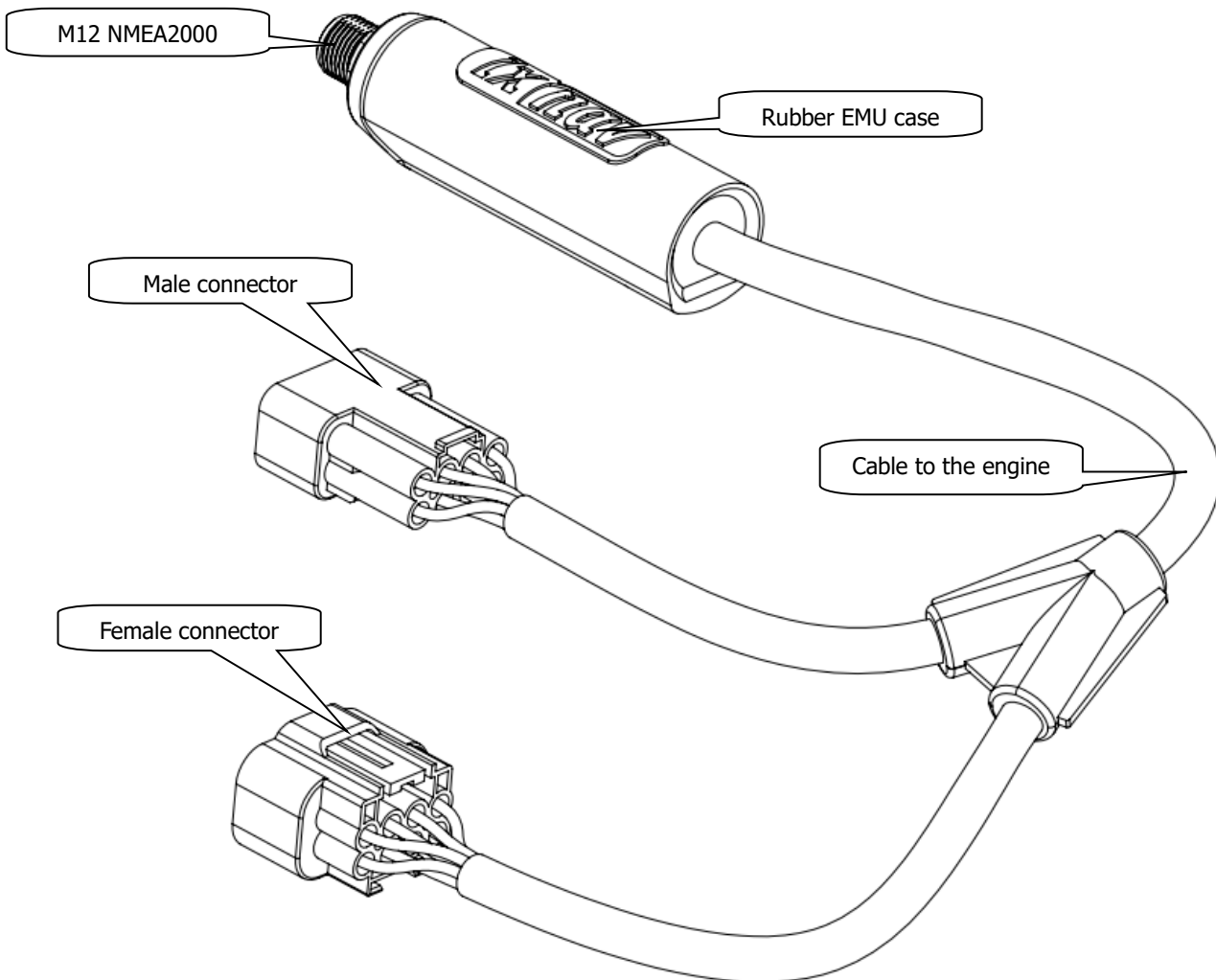

#### 3.1 NMEA2000 M12 connector pinout

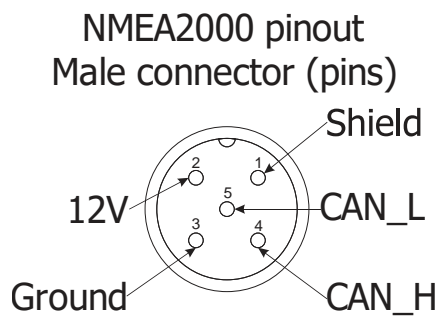

Figure 1: NMEA2000 M12 Male connector pinout (view from unit side)

### 3.2 Sensor connectors pinout

As shown on the picture below, the pinout is shown from the unit side (not from the included connector kit side). Each input/output has a corresponding ground connection for the sensor itself.

#### Male connector

(view from unit side)

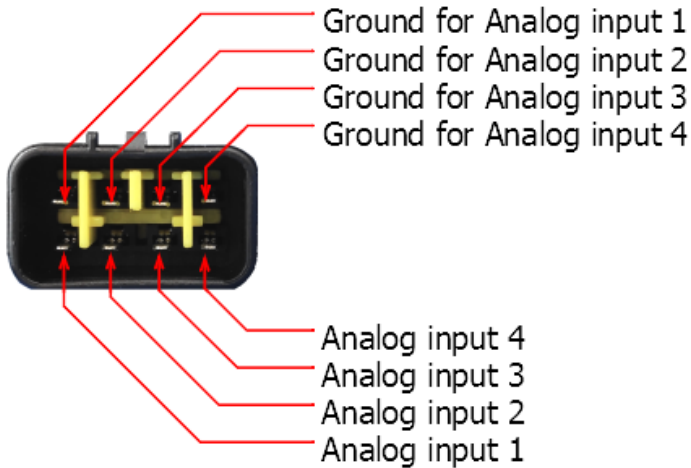

#### Female connector

(view from unit side)

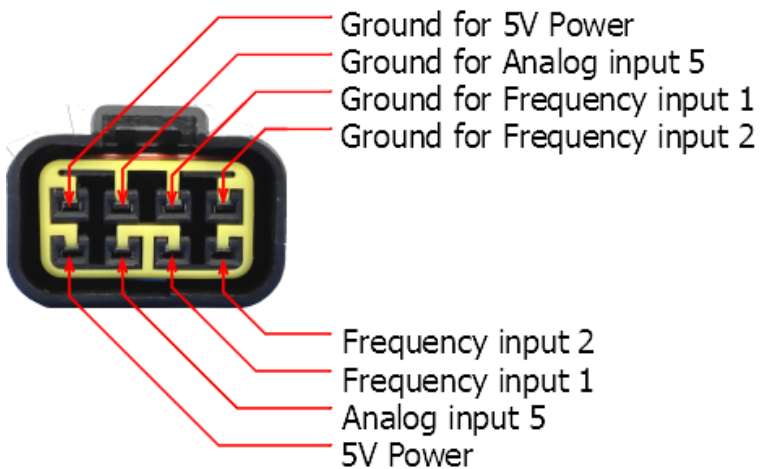

### 3.3 Connector kit

This chapter guides you through crimping the correct wires into the EMU connectors provided. Tools needed:

- Crimping pliers (recommended Engineer PA-01)
- Wire stripper

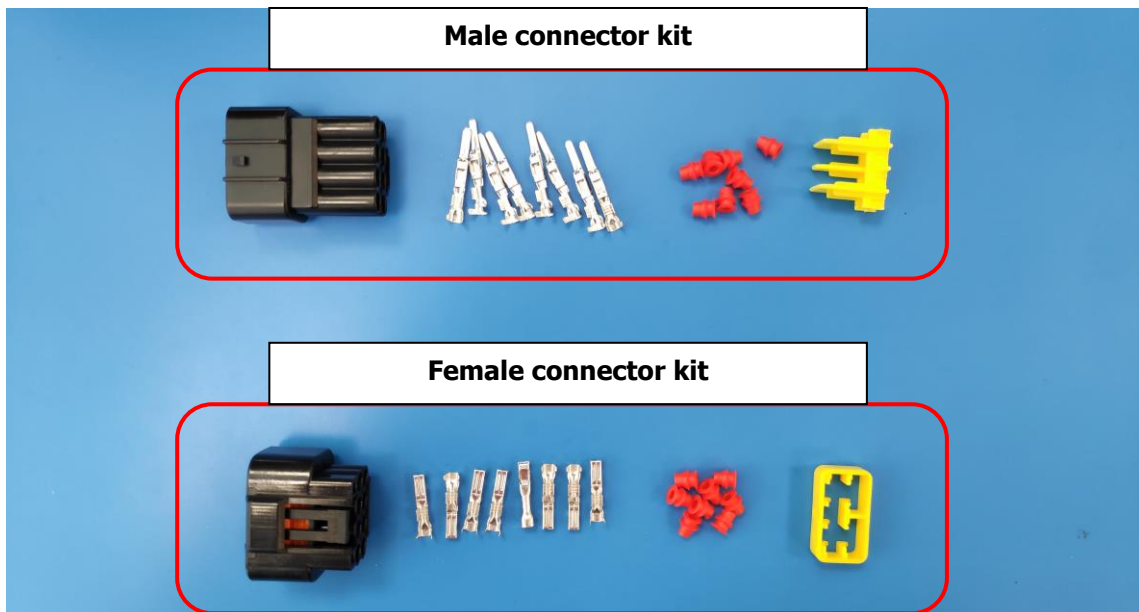

**Figure 2: Sensor connection kit**

Figure 2 shows the contents of the sensor connection kit. It contains:

- Male and female connector housing
- 8 crimp contacts for each connector (blade and socket)
- Watertight grommets
- Endcap for both of the connectors

### 3.4 Crimping and inserting wires

**Step 1:** Pull water grommet on wire and strip insulation off the copper. Stripped length should be somewhere around 5mm.

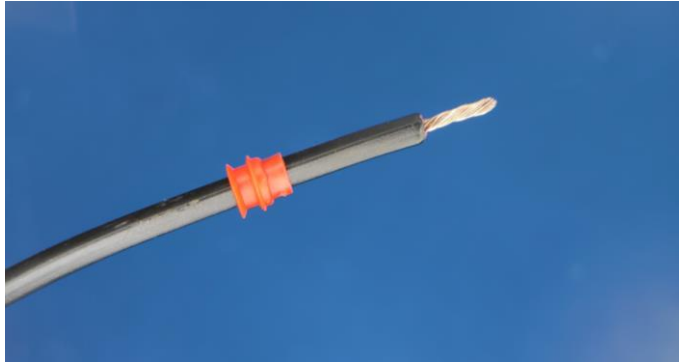

**Step 2:** Insert the crimp contact into the crimping pliers (die head 0.5mm) and gently grip the contact so that it stays put. Note that the pliers must only "grab" the grip shell on the crimp contact.



**Step 3:** Insert the wire into the crimp contact until you only see the insulation. Now apply pressure to the pliers all the way down.



**Step 5:** The result from step 4 should look like the picture below. Now pull the watertight grommet between last two opened crimp pads – see green box in picture bellow.

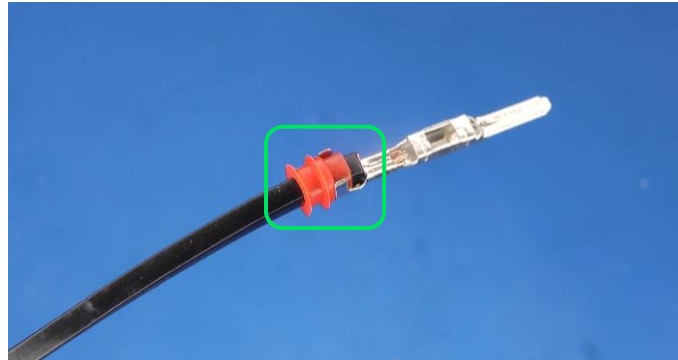

**Step 6:** Crimp the insulating shell with grommet together. Insert the crimped wire into the INS portion (or >2.5mm die size of a crimping plier) and apply pressure to the crimping tool.



The result should look something like the picture below



**Step 7:** Insert the crimped contact with the watertight grommet into the appropriate connector housing.



Make sure that you hear a click sound and the grommet slides inside (see picture below).



Repeat Step 1 through Step 7 until all of the connections are wired.

**Final step:** Insert the end cap into the connector so that it lines up with the outer shell.

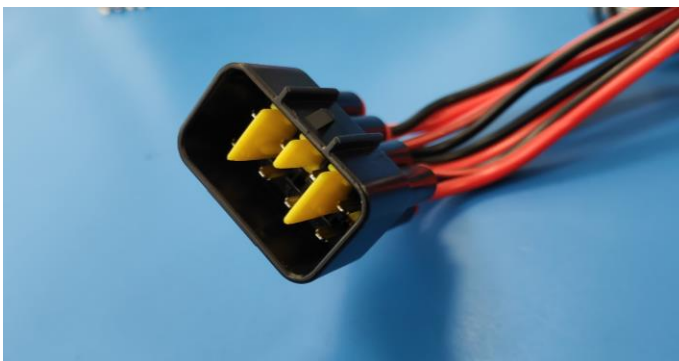

### 3.5 Examples for sensor connections

#### 3.5.1 Resistive type sensors

##### Male connector

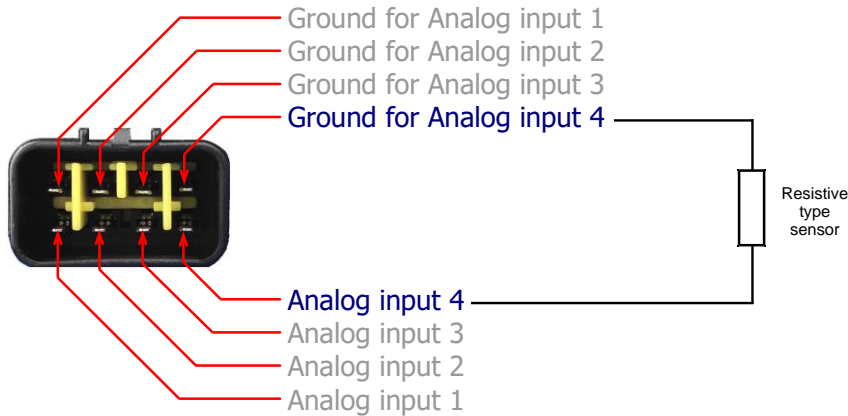
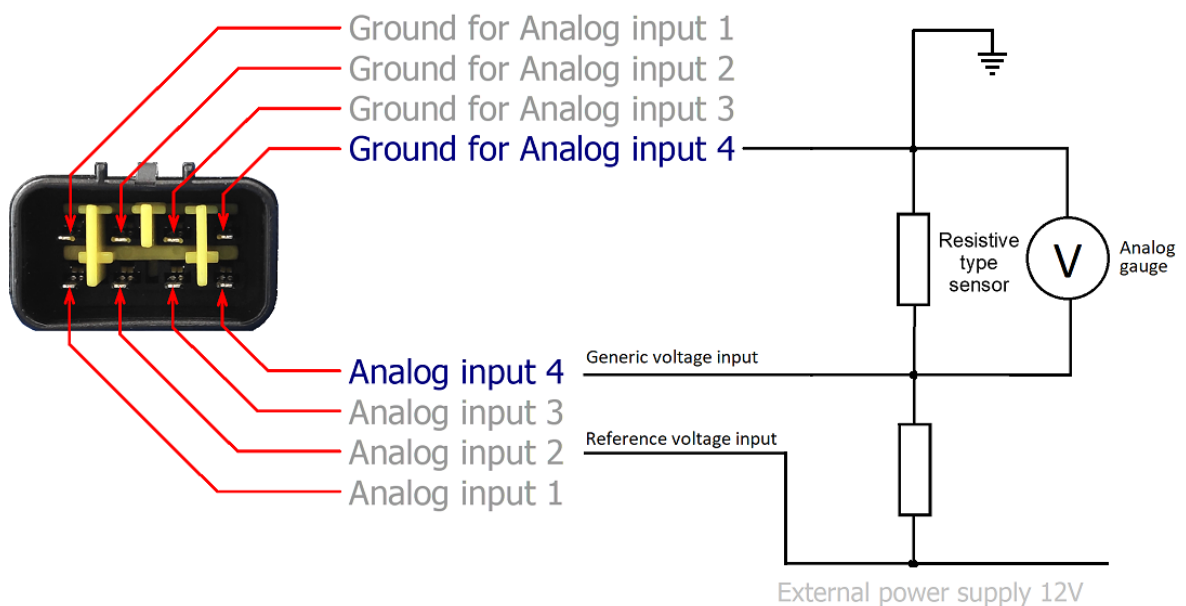

**Figure 3: Resistive type sensor connection (view from unit side)**

Note: Use adjacent ground connections for sensor pairs. There are pins for exactly 4 sensor (8 wires).

#### 3.5.2 Voltage type sensors with reference

In case that we want to keep old gauges for indication engine parameters, the EMU can be connected following way. The generic voltage input must be selected. Because the external power supply is not stable. Due to alternator, the power supply voltage may vary. The measurement on the sensor will also drift with like power supply. We can compensate that, if we use additional analogue input as voltage reference. At the end is necessary to enter at least two calibration points.



**Figure 4: Resistive type sensor with external supply (view from unit side)**

### 3.5.3 Voltage output type sensors

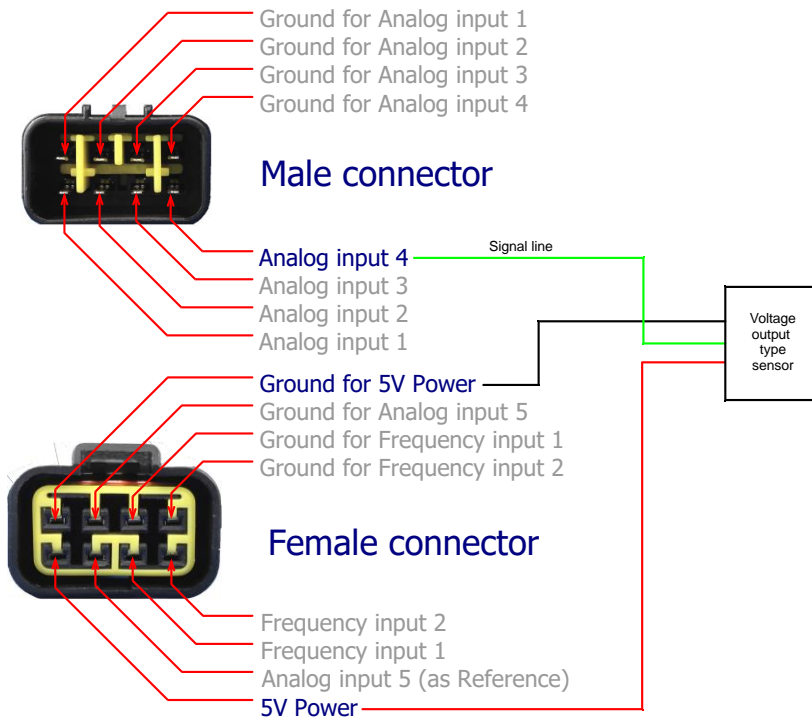

**Figure 5: Voltage output type sensor connection (view from unit side)**



### 3.5.4 Voltage output type sensors with external power supply

If we want to measure a value (eg. Fuel) from 3<sup>rd</sup> party system, an external voltage reference is necessary to be measured. For that purpose, we will configure one of analogue inputs as voltage reference. This pin will be connected to the power supply, where sensor is already supplied (black on the figure). Another input will be configured as "Generic voltage with reference". Then we can calibrate fuel tank.

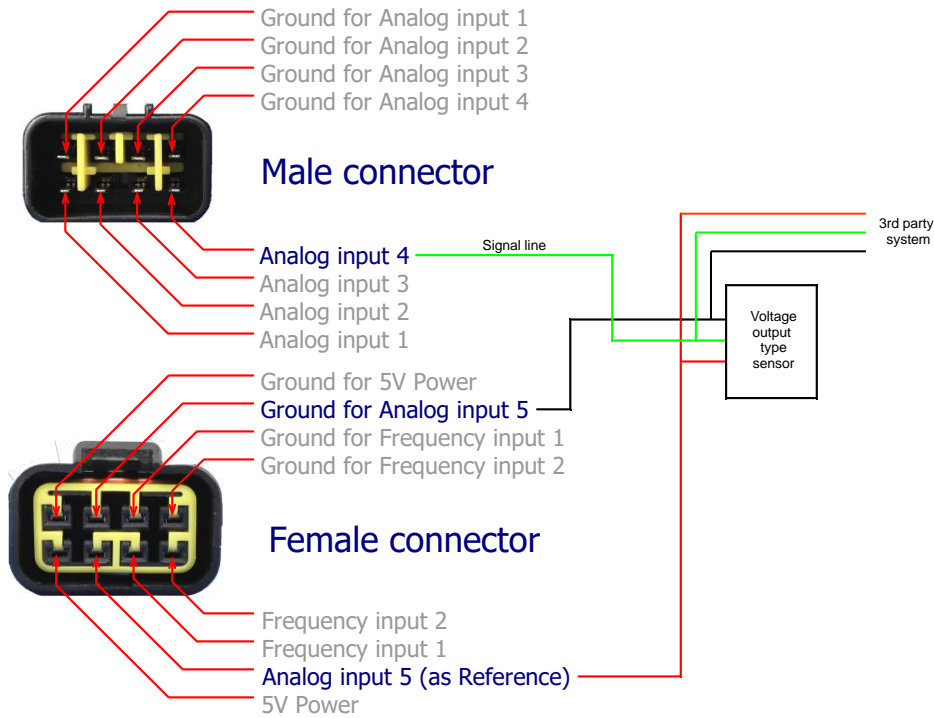

Figure 6: Voltage output type sensor with refernece connection (view from unit side)

### 3.5.5 Current type output sensors

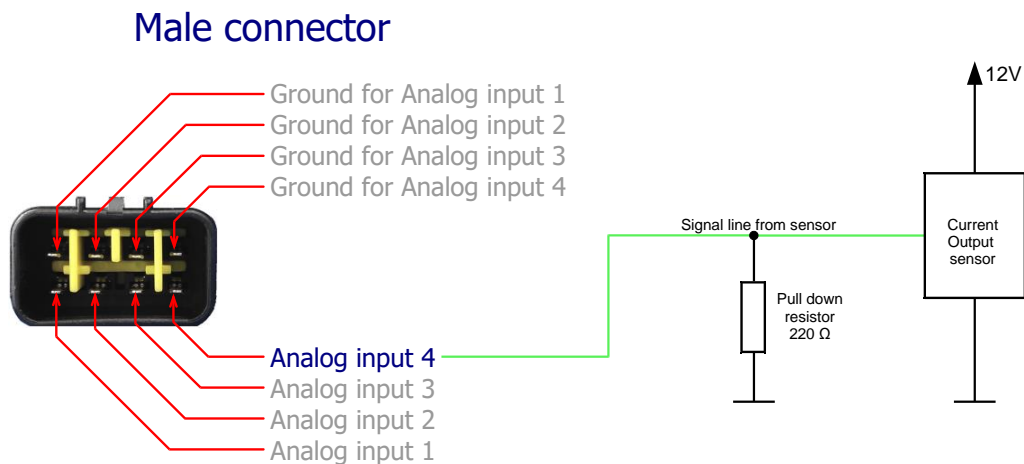
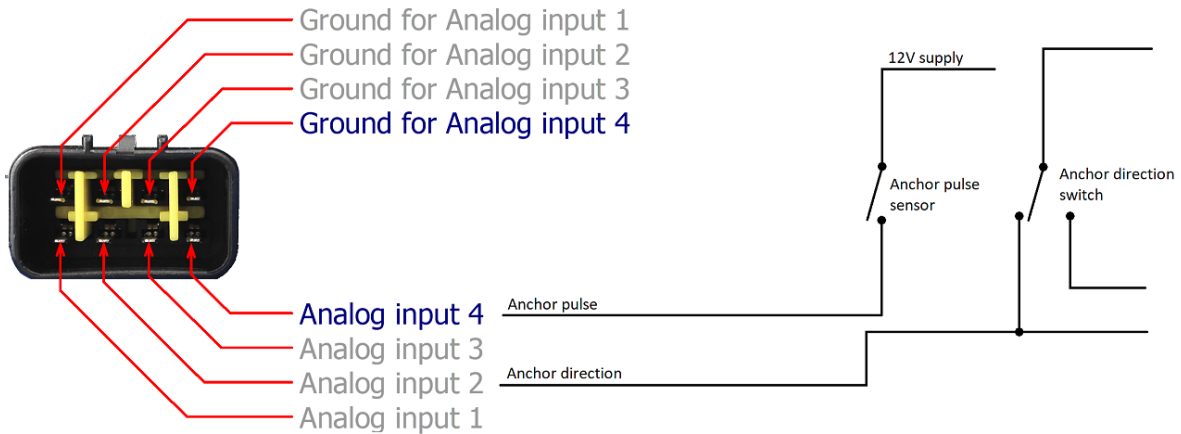

Figure 7: Current output type sensor (view from unit side)

### 3.5.6 Anchor sensor



### 3.5.7 Digital inputs

#### Male connector

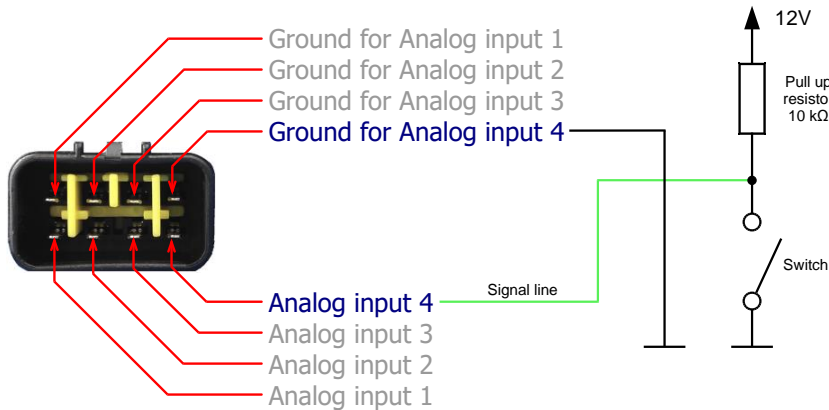

**Figure 8: Digital input used with external switch (view from unit side)**

### 3.5.8 RPM

The EMU provides for the digitization of engine speed data for a wide range of engines that were designed or built before the wide spread implementation of N2K data networks. These legacy engines fall into two main groups. Compression Ignition engines and Spark Ignition engines. Further these can be grouped mechanical control, Electronic control or Electronic control with IC (Micro computer / Logic)

EMU has two inputs for RPM sensors. They have an internal resistance of 51kΩ. They are designed for passive P-lead sensing, but with some external components, they can be used in other situations also.

In general legacy engines fall into the following groups.

- Outboard Motors
- Diesel Engines, Purpose built Marine and Marine adapted Automotive
- Petrol Engines, Marine adapted Automotive

### 3.5.8.1 Legacy Marine Engines

#### Outboard Motors

- Direct P-lead sensing from Lighting / Charge Coils
- Active P-lead sensing from ECU pin (Alternator equipped OB Motors)

**Direct P-lead** sensing from Lighting / Charge Coils is desirable because of low voltages and frequencies involved. This has long been the preferred method of major Outboard Motor producers. The line voltage is controlled indirectly by the state of charge of the start battery. For single or three phase systems you need only tap into one of the phase wires at the rectifier connection point. Often the engine manufacturer will provide a double header plug on one of the phase wires for this purpose.

Common flywheels have, 4,6 or 12 poles. You will need to know the number of poles to complete the calibration described in chapter 4.1.1.2.1.1

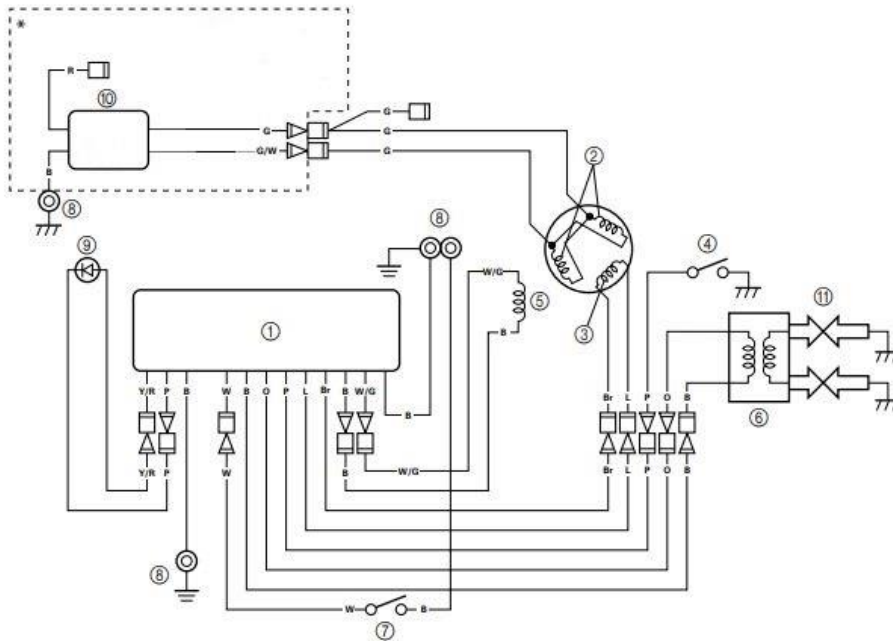

**Figure 9: Typical OB Motor Wiring #10 Rectifier #2 Charge Coils. At interconnection Extra socket can be found for Tacho Sensing**

**Active P-lead** sensing from ECU pin. At the close of the twentieth century there was a general race between outboard manufacturers to increase the output of their battery charging systems. Some builders choose fit alternators. In such cases it is likely that the ECU will have been adapted or newly developed to provide a synthetic "charge coil" pulse. This was a general practice driven by the will to have standard Tachometers for all models.

#### Diesel Engines

- Passive P-lead sensing from Injector Pump (Inductive Pickup)
- Passive P-lead sensing from Alternator (Bosch W Terminal)
- Active P-lead sensing from ECU pin

**Passive P-lead** sensing from injector pump pickup. On Diesel engines with mechanical injector pumps, take time to inspect the pump for any electrical connection. Commonly you may find a fuel cut (stop) solenoid. In addition many injector pumps are fitted with a Inductive Pickup specifically to measure engine RPM

**Passive P-lead** sensing from the alternator. This is very similar to the charge coil connection on and Outboard Motor. In this case the a connection is made inside the alternator. The pulse is taped to one of the phase connections before the rectifier assembly. The most commonly used marine alternators are 12 pole, however you must consider also the overdrive ratio of the alternator drive. Typically the alternator speed is three or more times greater than the engine speed.

**Active P-lead** sensing from ECU pin. More advanced Diesel engines included electronic control of the injector pump and later direct control of injectors on common rail engines. On such engines it is very common to find a pin on the ECU which outputs a synthetic pickup coil pulse.

Most high-speed marine diesel engines will tolerate running at high idle without danger of internal damage. Check with your engine builder! In such cases the injection system controls the engine speed in very tight control at max speed with no load (Idle). Typical margin may be just +/- 30 RPM. This speed <High Idle> will be publish on the engine spec sheet and is ideal for checking / adjusting calibration of Tachometer.

Petrol Inboard Engine

- Direct P-lead sensing from Ignition Coil (Primary Coil)
- Passive P-lead sensing from Alternator (Bosch W Terminal)
- Active P-lead sensing from ECU pin

**Direct P-lead** sensing from the ignition coil is an acceptable solution but has some risk of high voltage exposure back EMF and so on. Please review Magneto comments below as some of these ideas could be relevant to this method. Typically the ignition coil it sensed at the (-) of the primary coil. There is a direct connection to the secondary winding inside the coil, which under certain condition deliver high voltage spikes. Assuring a perfect grounding of the coil enhance proper ignition and greatly reduces risk of unwanted spikes/ interference.

**Passive P-lead** sensing from the alternator. See details in Diesel section above. However in this case more effort is required. You will need to measure / calculate the overdrive ratio. Then research pole count for the alternator used. Given this data the RPM vs. Pulse rate factor can be calculated.

**Active P-lead** sensing from ECU pin. Modern petrol engines with electronic ignition, EFI, MPI normally have ECU adapted or developed to drive legacy marine tachometers. On such engines it is very common to find a pin on the ECU which outputs a synthetic pickup coil pulse.



Petrol engines are not tolerant of running at high speed with no load. Such practice should be strictly avoided.

**3.5.8.2 More Exotic RPM sensing**

- Direct P-lead sensing from magnetos - Figure 10: Direct P-lead sensing
- Active P-lead sensing from magnetos (JPI 420815) - Figure 11: Active P-lead sensing from magnetos
- Passive P-lead sensing from magnetos (inductive pickup) - Figure 13: Passive P-lead sensing from magnetos

**Direct P-lead** sensing from magnetos is the least preferable way of measuring RPM. Because of high voltage spikes on magnetos, user must include a series resistor that has a value of 33kΩ. If the readings are unstable, the user must increase the value of the resistor (100kΩ or more) until the issue is resolved. Be sure to mount the resistors near the ignition switch, since magnetos are high voltage spikes that cause a lot of EM interference. This is the least preferable way of measuring RPM, because it does not isolate EMU from the damaging high voltage spikes generated on the magnetos.

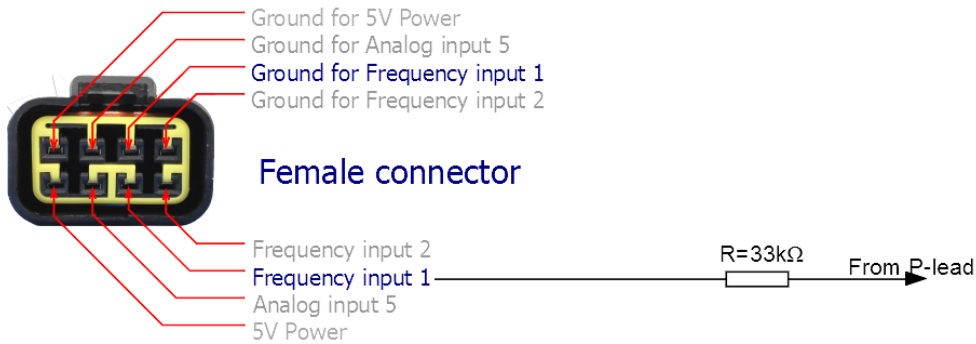

**Figure 10: Direct P-lead sensing (view from unit side)**

Active P-lead sensing from magnetos is a preferred method of measuring RPM. Sensors like the JPI 420815 have an open-collector digital output (no high voltage spikes) and isolates the EMU from the magnetos. **Napaka! Vira sklicevanja ni bilo mogoče najti.**7 shows connection for such a sensor. Since RPM inputs on the eBox have no internal pullup, user must include a pullup 2.2kΩ to +12V.

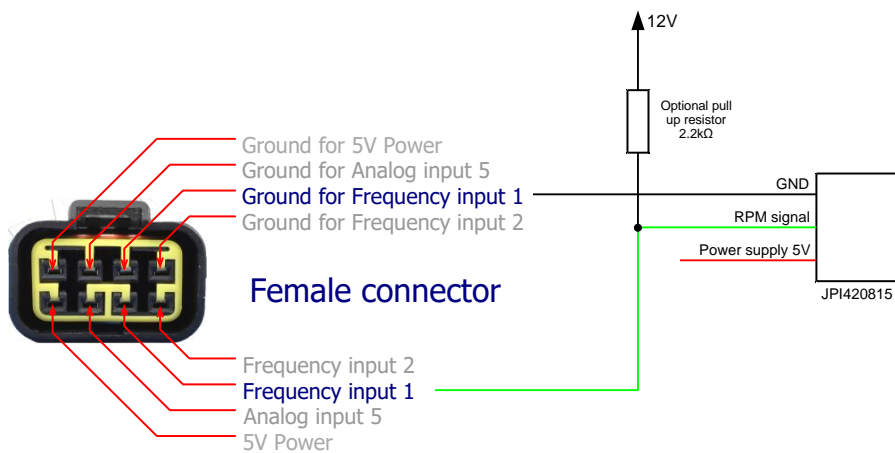

**Figure 11: Active P-lead sensing from magnetos (view from unit side)**

Passive P-lead sensing is also an option for measuring RPM with eBox. A good example is the Rotax 912 which has a passive inductive pickup. Figure 12 shows the connections for this kind of sensing.

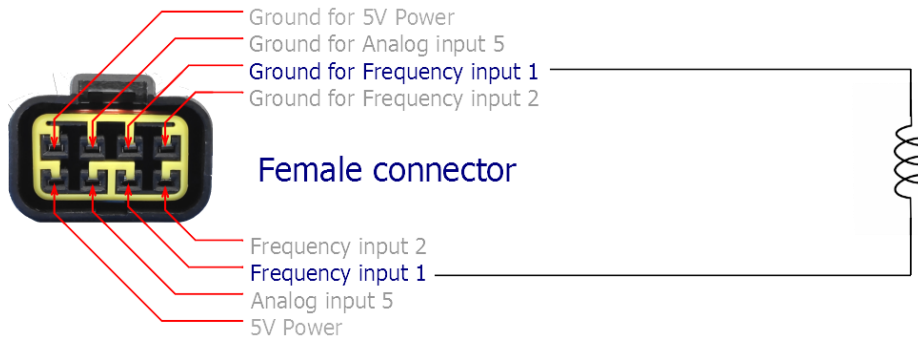

**Figure 13: Passive P-lead sensing from magnetos (view from unit side)**

## 4 Configuring EMU

To operate properly EMU must be configured properly for each sensor connected to particular port. Configuration can be performed via WiFi connection or via CAN bus with one of LXNAV compatible devices.

### 4.1.1 Configuration via WiFi

EMU has integrated WiFi hot spot, to which you can connect with your smart phone. Password can be copied from label on EMU unit or QR code. You may get a message from the system, that there may not be available internet connection. You must run a web browser on your smart phone and enter IP address <http://192.168.4.1>. Or simply run Android or IOS app LXNAV emuConfig which can be downloaded from the GooglePlay.

Configuration consist of three pages. Home, Config and Info

#### 4.1.1.1 Home

On home page user can view all configured sensor data.

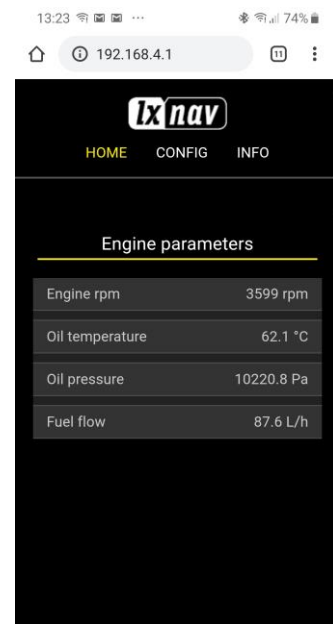

#### 4.1.1.2 Config

On this page user configure function of each port of the EMU. EMU has 2 digital inputs and 5 analogue inputs.

Digital inputs have following functions:

- RPM
- Fuel flow
- Binary

Analog inputs can be configured for following functionality:

- Fluid level
- Oil pressure
- Oil temperature
- Engine temperature
- Rudder angle
- Voltage reference

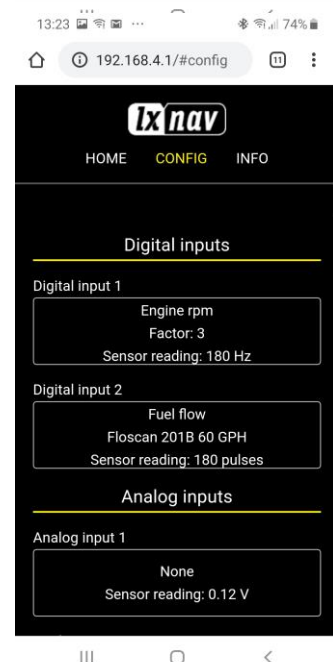



### 4.1.1.2.1 Digital input functions

#### 4.1.1.2.1.1 RPM

In RPM configuration menu, we can set multiplying factor, to match number of pulses with number of revolutions per minute of the engine.

In this page we can set also an engine hours.

All changes must be saved if we want to keep them.

The basic formula to calculate factor is:

Multiplication Factor = Number of pulses per revolution.

#### 4.1.1.2.1.2 Fuel flow

If we select fuel flow sensor for digital input, we must select the type of the connected fuel flow sensor. On the market is plenty of different fuel flow sensors. Each sensor gives defined number of pulses per volume (litre or gallon)

#### 4.1.1.2.1.3 Binary input

Can be configured to send via NMEA2000 standard warning, a status of binary input. Available list of warnings is on the list in the application.

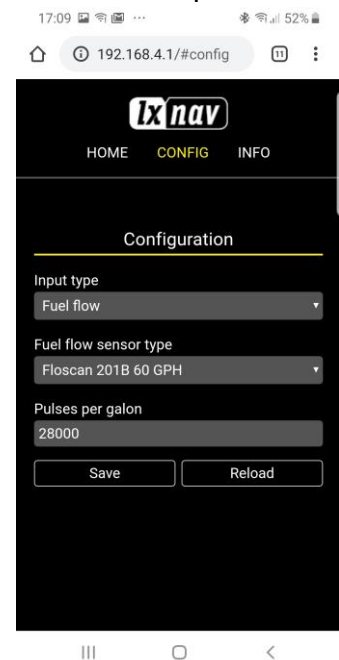

### 4.1.1.2.2 Analog inputs functions

#### 4.1.1.2.2.1 Fluid level

If input type is configured as **fluid level**, next setting is sensor type. Supported sensor types are resistive and voltage sensors. Next setting, which must be selected is the type of the fluid and last the tank volume.

EMU has capability to calibrate fluid tank in 12 points. Calibration is stored in the EMU unit. All changes must be confirmed with save button.

#### 4.1.1.2.2.2 Oil pressure

If input type is selected oil pressure, we need select just a sensor type connected to that input.

#### 4.1.1.2.2.3 Oil temperature

If input type is selected oil temperature, we need select just a type of temperature sensor connected to that input.

#### 4.1.1.2.2.4 Engine temperature

If input type is selected engine temperature, we need select just a type of temperature sensor connected to that input.

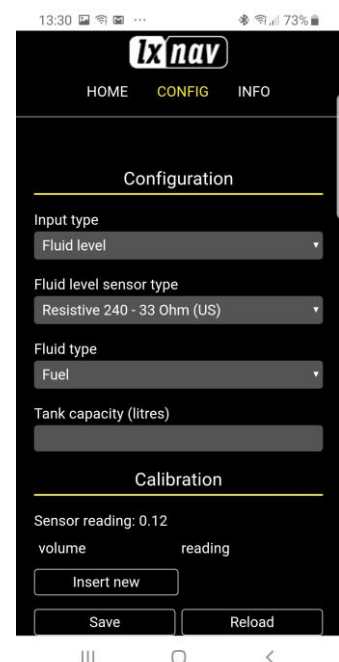

#### 4.1.1.2.2.5 Rudder angle

If input type is selected rudder sensor, we need select just a type of rudder sensor connected to that input.

#### 4.1.1.2.2.6 Binary input

If to the input configured as binary, input is connected voltage signal, EMU will send a selected type of binary signal over NMEA2000 network. Normally 12V signal means logical HI

state and 0V means logical LO state. With invert polarity we can invert logical status of the signal. Means, that at LO state a warning will be transmitted to NMEA2000 network, normally warning is transmitted when logical state is HI.

#### 4.1.1.2.2.7 Voltage reference

**Voltage reference** input is used, when we want to connect parallel to existing measurement system. For example, we want to measure fuel level and we want to connect to existing analogue gauge. In this case the voltage reference pin will be connected to power supply of the gauge/sensor that is used for measurement of the fuel level. Another input must be assigned as **fluid level** and sensor type must be selected as **generic voltage with reference**. In this case the minimum reading of the sensor is at 0V, maximum reading of the sensor is at voltage that is measured on voltage reference input pin. In the case of the fuel level sensor, it can be still calibrated in 12 custom points.

### 4.1.1.3 Info

On info page is information about EMU unit serial number, firmware version,...

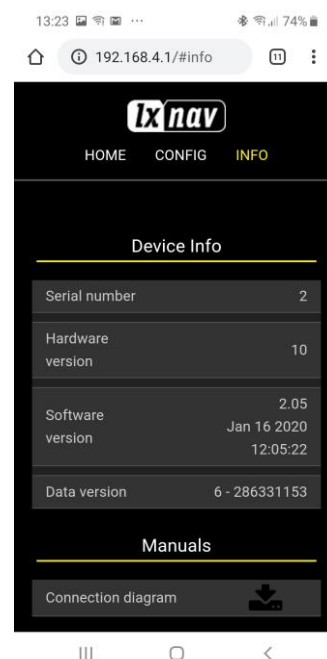

## 4.1.2 Firmware update

Firmware update can be performed via NMEA2000 network or via Wifi.

### 4.1.2.1 Firmware update over NMEA2000 network

To perform firmware update via NMEA2000 network, you need one of LXNAV NMEA2000 displays connected to network (e350,e500,e700,e900).

### 4.1.2.2 Firmware update using WiFi

- Please download with smart phone the latest firmware from the LXNAV web site.
- Connect to the Wifi of the SmartEMU

- Go under device info menu

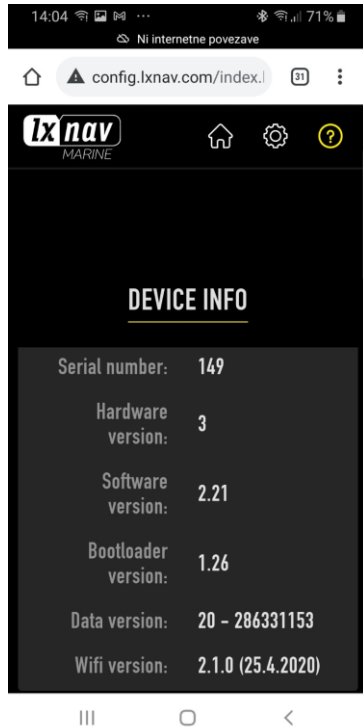

- Scroll down and press BROWSE

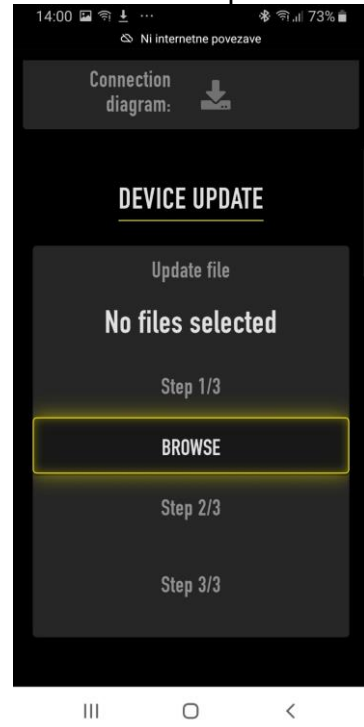

- Select the downloaded firmware file (normally it is downloaded into downloads folder) and press UPLOAD

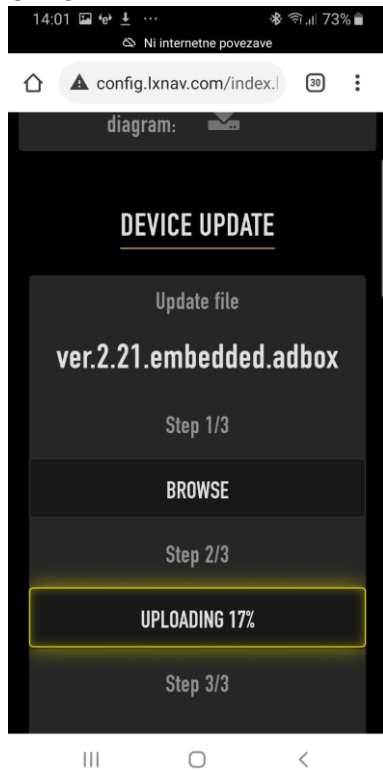

- When upload is COMPLETED, press UPDATE

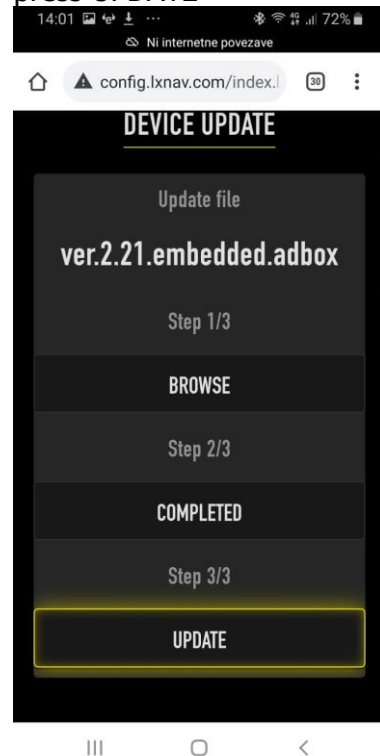

- Please wait a minute and device will be updated with new firmware.

## 5 Supported data

### NMEA 2000 compliant PGN

#### List NMEA 2000 PGN (transmit)

59392	ISO ack
59904	ISO request
60160	ISO transport protocol - data transfer
60416	ISO transport protocol - command
60928	ISO address claim
61184	ISO proprietary a
65280	ISO proprietary b
126208	Group function
126720	ISO proprietary a2
126996	Product information
127505	Fluid level
127245	Rudder
127488	Engine parameters, rapid update
127489	Engine parameters, dynamic
127493	Engine transmission parameters
127505	Fluid level
130825	Proprietary LXNAV message fast broadcast
130884	Proprietary LXNAV raw fast broadcast

#### NMEA 2000 PGN (Receive)

59392	ISO ack
59904	ISO request
60160	ISO transport protocol - data transfer
60416	ISO transport protocol - commands
60928	ISO address claim
61184	ISO proprietary A
65280	ISO proprietary B
126208	Group function
126720	ISO proprietary A2
130816	Proprietary multipart broadcast
130825	Proprietary LXNAV message fast broadcast
130884	Proprietary LXNAV raw fast broadcast

## 6 Revision history

Date	Revision	Description
June 2019	1	Initial release of this manual
July 2019	2	Added image descriptions for connector pinout clarity Corrected connector polarity
January 2020	3	New pinouts, sensor wirings.
January 2020	4	Technical data rewritten
April 2020	5	Modified chapter 3.4
April 2020	6	Added supported pgn list 5
July 2020	7	Updated chapters 2.3, 3.5
May 2021	8	Added Chapter 4.1.2
April 2022	9	Updated chapter 2.3.2, added chapter 3.5.2, 3.5.6
October 2023	10	Updated chapter 3.5.2