

ShipModul

Marine Electronics

MiniPlex-41BT NMEA-0183 multiplexer Manual

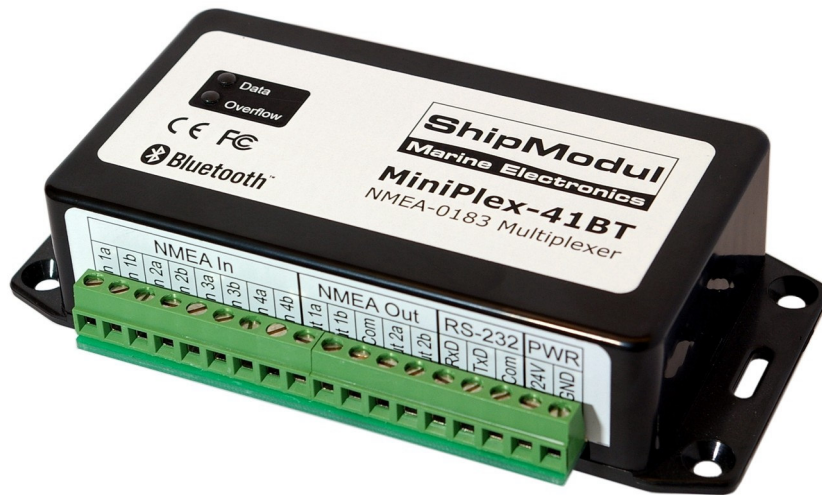

MiniPlex-41BT, V2.0
Firmware V2.2.4
Art.no.: 105

© CustomWare, 2005

Introduction

The MiniPlex-41BT is a four-channel NMEA multiplexer, enabling the connection of multiple NMEA-0183 instruments to each other and a computer. Available are four NMEA inputs (*listener*-ports), two NMEA outputs (*talker*-ports), a serial port (RS-232) and a Bluetooth interface for a wireless connection with a computer or PDA (Personal Digital Assistant, like Windows CE PDA's or Palm PDA's).

Specifications:

Supply voltage:	8 – 30 V _{DC} , protected against reversed polarity.
Current consumption:	100 mA (150 mA max. with fully loaded talker ports and active Bluetooth connection).
Inputs:	4 x NMEA-183/RS-422, galvanically isolated.
Input resistance:	>800 Ohm.
Outputs:	1 x RS-232, 2 x NMEA-183/RS-422, 1 x Bluetooth
Buffers:	6 buffers of 800 characters (4 x NMEA, 1 x RS-232, 1 x Bluetooth).
NMEA Out1:	Combined data from NMEA inputs.
NMEA Out2:	Combined data from NMEA, Bluetooth and serial inputs or only from Bluetooth and serial input.
Speed NMEA in:	4800 Baud.
Speed NMEA out 1 / RS-232	4800 - 38400 Baud (NMEA HS).
Speed Bluetooth:	38400 Baud internal, any speed selectable on computer.
Speed NMEA out 2:	4800 Baud.
Indicators:	Overflow and Data.
Bluetooth Device Name:	"MiniPlex 41BT"
Bluetooth Pass Key (PIN):	"0000"
Bluetooth transceiver:	Type: TDK TRBLU20-00100, Class 1 device. FCC ID: PI4-TDK-BTISM. Canada: 1931-TDK-BTISM.
Dimensions:	138 x 72 x 33 mm.
Housing:	Flame retardant ABS.

Operation

The MiniPlex-41BT reads NMEA sentences from the listener ports and stores them in a buffer, one for each input. The sentences are read from the buffers in a round robin fashion, one sentence at a time, giving each listener port equal priority. Each sentence is then sent to the talker port(s), the Bluetooth interface and the RS-232 port. Also, sentences received from the RS-232 port and the Bluetooth interface, are sent to the talker port NMEA Out2.

The matrix below shows which information is available on what port.

	NMEA In 1	NMEA In 2	NMEA In 3	NMEA In 4	Bluetooth In	RS-232 In
NMEA Out 1	H/S	H/S	H/S	H/S		
NMEA Out 2	H	H	H	H	H/S	H/S
Bluetooth Out	H/S	H/S	H/S	H/S		H
RS-232 Out	H/S	H/S	H/S	H/S	H	

H: Hub mode, S: Server mode

The speed of the listener ports is fixed to 4800 Baud (= bits per second), which equals 480 characters per second. When all listener ports receive data at this rate, the buffers will not be emptied in time and an overflow situation occurs. The red LED indicates this situation. When a buffer is full, a partially received sentence will be discarded, to ensure that the MiniPlex-41BT only sends complete and valid NMEA sentences.

There are two ways to resolve this overflow situation:

1. Configure the instruments on the listener ports to send less data or with greater intervals. It is often possible to disable non-relevant sentences.
2. Set the operation mode of the multiplexer to Server mode (factory default). This mode only sends incoming data to the computer/PDA and to NMEA Out1, which is high speed. In Hub mode, the high speed ports must wait for every character to be transmitted over the low speed NMEA Out 2 port.

The MiniPlex-41BT has two talker ports, 'Out 1' and 'Out 2'. All received sentences from the listener ports are available on talker port 'Out 1'. Talker port 'Out 2' can be configured either to output all received sentences from the listener ports and the computer/PDA (Hub Mode), or only sentences from the computer/PDA (Server Mode).

Connections

NMEA Listener Ports

The MiniPlex-41BT has four listener ports, 'In 1' to 'In 4'. Each listener port should be connected to one instrument only. These inputs are galvanically isolated from the multiplexer, as specified in the NMEA-0183 standard.

Connect the 'a' and 'b' terminals of the listener port on the MiniPlex-41BT to the 'a' and 'b' terminals of the talker port on the instrument. Other designations used are 'Data +' and 'Data -', 'TX+' and 'TX-' or 'Out +' and 'Out -'.

Some instruments have single ended talker ports, with only one data terminal. Connect this terminal to the 'a' terminal on the MiniPlex-41BT, and connect the 'b' terminal on the MiniPlex-41BT with the instrument ground.

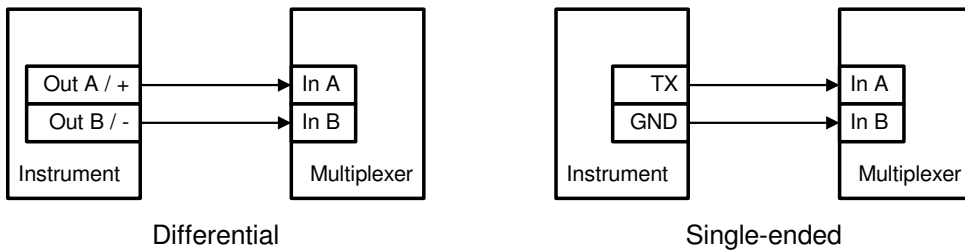

NMEA Talker Ports

Both talker ports can be connected to up to four instruments. Connect the 'a' and 'b' terminals of the talker port on the MiniPlex-41BT to the 'a' and 'b' terminals of the listener port(s) on the instrument(s). Other designations used are 'Data +' and 'Data -', 'RX+' and 'RX-' or 'In +' and 'In -'.

Some instruments have single ended listener ports, with only one data terminal. Connect this terminal to the 'a' terminal on the MiniPlex-41BT, and leave the 'b' terminal on the MiniPlex-41BT unconnected. Connect the 'Com' terminal on the MiniPlex-41BT with the instrument ground.

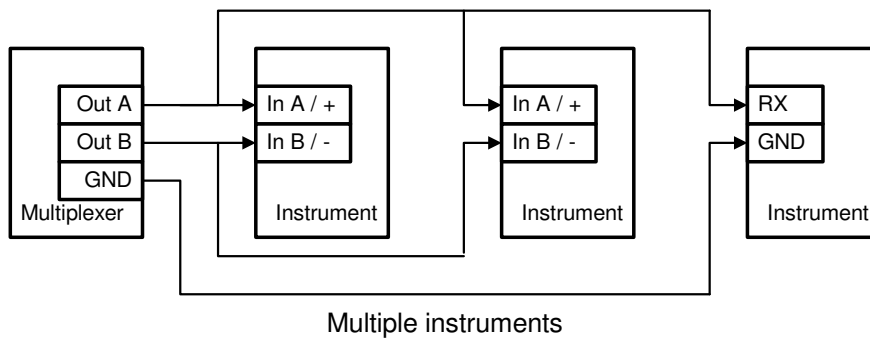
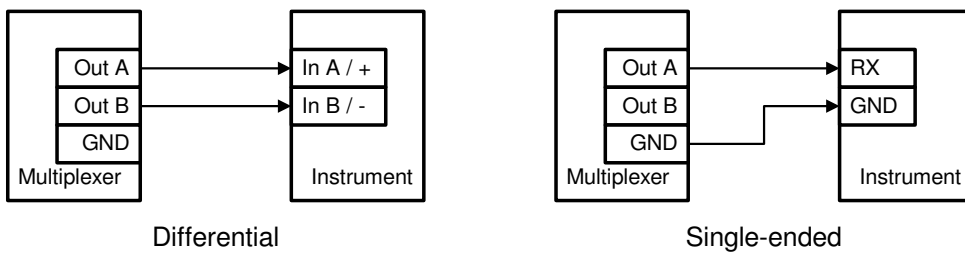

Bluetooth

The MiniPlex-41BT communicates with a computer or PDA through its Bluetooth interface, allowing the computer/PDA to receive all incoming NMEA data. The computer/PDA can also send data back to the multiplexer, which can be used to control an autopilot connected to NMEA Out2.

The Bluetooth interface uses the 'Serial Profile', which means that on the computer/PDA, this connection is presented as a standard COM port. Such a COM port can be opened by any application. To setup a connection, the MiniPlex-41BT must be paired to your computer/PDA. Pairing is a process that makes a Bluetooth device know to a computer and vice versa, by their unique address. Pairing is initiated on the computer or PDA by issuing the appropriate commands on the respective devices. Mostly this will be something like 'Find Bluetooth Devices'. This operation will show a list of Bluetooth devices in the near surroundings that have responded to the computer's/PDA's inquiry scan. The MiniPlex-41BT will be listed as "MiniPlex41BT". Select the MiniPlex41BT entry and enter the required passkey when asked. The passkey of the MiniPlex-41BT is '0000' (four zeros). Follow the directions of your Bluetooth adapters' software to finish the pairing process and assigning it to a COM port (in case of a computer). This COM port will now be assigned to the MiniPlex-41BT.

Your navigation software can now open this COM port and function as normal. Depending on the implementation of the bluetooth software on your computer/PDA, it might ask for the passkey when you start your navigation software.

Data which is sent over the Bluetooth connection will appear at NMEA Out2 but also at the serial port of the multiplexer when configured in Hub-mode.

RS-232 Computer Port

The RS-232 port on the MiniPlex-41BT can be connected directly with the serial port of a computer, as shown in the diagram below.

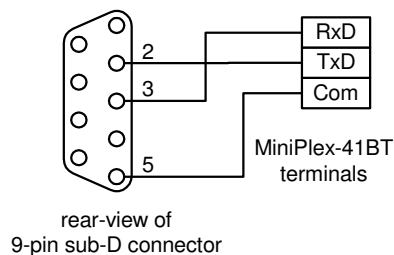

The serial port behaves in exactly the same way as the Bluetooth interface. All received NMEA data is available at the serial port as well as at the Bluetooth interface. If data is sent to the serial port in Hub-mode, it will not only be sent to the NMEA Out2 port, but also to the Bluetooth interface.

The serial port is set to 38400 baud when shipped. It can however be set to any speed in the range from 4800 to 38400 baud using the MPX-Config utility.

Power Supply

The MiniPlex-41BT operates from a DC supply voltage from 8 to 30V and is protected against reversed polarity. It is recommended to connect the MiniPlex-41BT to the same power source or circuit breaker as the ships instruments and/or computer.

Configuration

Various options can be configured on the MiniPlex-41BT, using the supplied configuration program MPX-Config. There is no installation procedure for this utility, just start it from the CD or copy it to a suitable folder on the harddisk of your computer.

The top part of MPX-Config shows the NMEA sentences which are received by the multiplexer. The bottom part has all the configuration controls. The File menu allows you to store the configuration settings of the multiplexer to a file or load the configuration from a file. This file format is similar to the Windows INI file format, allowing editing the files with a text editor. Appendix A shows an example of a configuration file.

The MiniPlex-41BT is configured with proprietary NMEA sentences. MPX-Config sends these sentences to the multiplexer but they can also be issued with a terminal program. See Appendix B for a complete reference of the supported proprietary sentences.

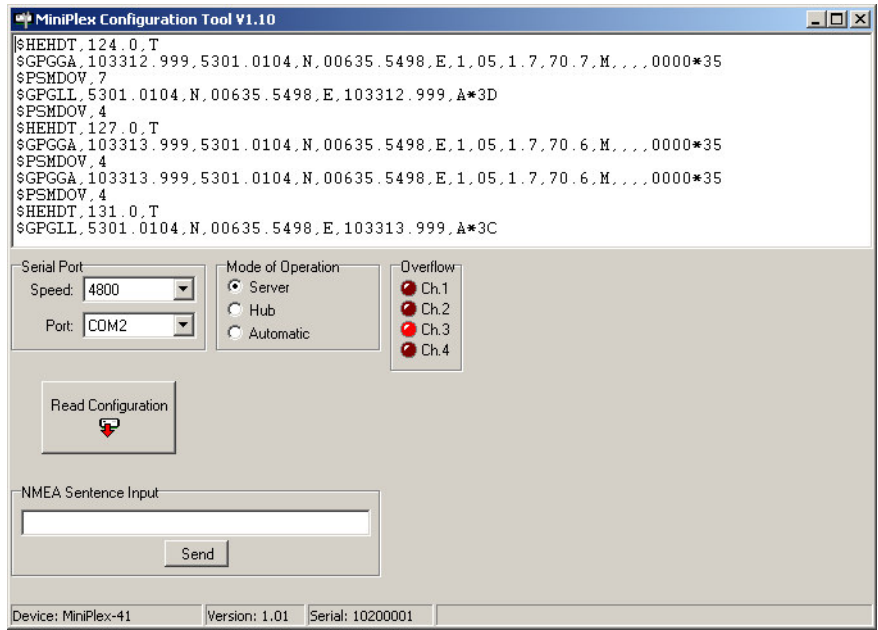

Screenshot of MPX-Config

Connecting

The MiniPlex-41BT can be configured with MPX-Config, a utility that talks to the multiplexer through a Bluetooth connection or the serial port. Before being able to configure the MiniPlex-41BT, select the COM port to which the multiplexer is paired using Bluetooth or the physical COM port when using a direct serial connection. When selecting the baudrate for the first time, choose 38400 (factory setting) or choose 'Automatic' to let MPX-Config detect to what speed the multiplexer has been set. This may take a few seconds, especially when instruments are sending data to the multiplexer. When a 'Multiplexer does not respond' - message appears, set the speed manually.

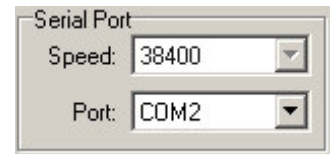

Read Configuration

Every time you start MPX-Config, it will request the current configuration from the MiniPlex-41BT. When this is unsuccessful (various controls on the MPX-Config window are greyed), you can manually request the current configuration with this button.

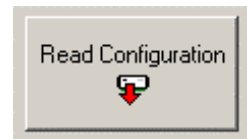

The status line on the bottom of the MPX-Config window will show the name of the multiplexer, the internal software version, the serial number and the optionally loaded configuration file.

Mode of Operation

The MiniPlex-41BT can operate in three different modes: Server, Hub and Automatic. Basically, these modes determine which NMEA data is available on NMEA Out2.

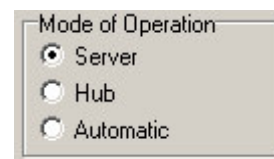

- Server mode:** In this mode, the combination of computer/PDA and multiplexer acts as an NMEA server. Incoming NMEA data from NMEA In1 to In4 is sent to the computer/PDA over the Bluetooth link or the serial port. Only NMEA data from the computer/PDA is available on NMEA Out2.
- Hub mode:** In Hub mode, the multiplexer acts as a hub where all NMEA data comes together and is sent out again. All incoming NMEA data, from NMEA In1 to In4 and the computer/PDA, is available on NMEA Out2. This mode has one limitation: since the NMEA data is sent to the Bluetooth port *and* NMEA Out2, the total throughput is limited by the speed of NMEA Out2, which is fixed to 4800 baud. Even while the Bluetooth or serial port are set to 38400 baud, the throughput will be 480 characters per second, the same as on NMEA Out2.
- Auto mode:** When Auto mode is selected, the multiplexer automatically switches between Hub- and Server mode, depending on the presence of computer/PDA generated data. When the computer sends NMEA data to the multiplexer (on the Bluetooth or serial interface), the multiplexer is in Server mode. When no data is received on the Bluetooth interface, the multiplexer will switch to Hub mode after a time out of 10 seconds.

Auto mode is very useful when sailing alternately with our without a laptop. Consider a typical setup as shown below:

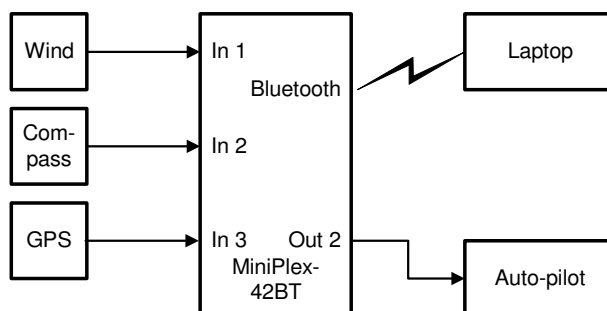

When the laptop is on board, it will receive all information from the instruments and the running navigation software is able to calculate the course to steer and drive the autopilot accordingly. Because the laptop is sending NMEA data, the multiplexer is in server mode and the autopilot will therefore receive information from the laptop only.

When the laptop is not on board, the multiplexer switches to in hub mode and sends all data from the instruments directly to the autopilot. This way, the autopilot will receive course information directly from the GPS.

NMEA Out1 is not affected by the mode setting. On this output, only NMEA data from the NMEA inputs is available at the same speed as the serial port.

Overflow

The overflow indicators on the MPX-Config screen can be used to determine which channel is causing an overflow. The LED corresponding to the compass channel will be lit almost continuously. Running the multiplexer in Server mode will never result in overflow or long delays.

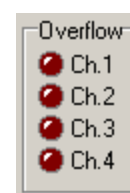

Manual NMEA input

MPX-Config allows manual entry of NMEA sentences for testing, configuration etc. Type the desired NMEA sentence in the edit box as shown on the right and press the Send button or the enter key. Do not precede the NMEA sentence with a '\$' as MPX-Config will do this for you. The input is case sensitive, so whatever you type will be sent literally to the multiplexer. Since all NMEA commands are uppercase, you have to enter them as uppercase.

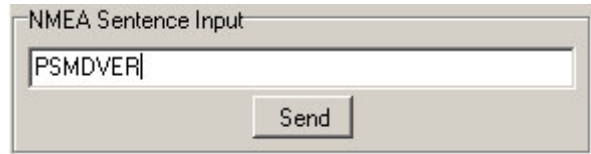

Indicators

The MiniPlex-41BT has two LED's. The green LED indicates the reception of valid NMEA data on the listener ports or the Bluetooth port. The LED only blinks on valid NMEA sentences that start with a '\$' or '!' and end with a LF character, thus indicating a proper connection and polarity of the connected instrument. In case of a reverse polarity, the green LED will not blink.

The red LED indicates a buffer overflow, in case more data is coming in than can be transmitted. When a buffer is full, a partially received sentence will be discarded, to ensure that the MiniPlex-41BT only passes complete and valid sentences.

There are three ways to resolve this overflow situation:

1. Configure the instruments on the listener ports to send less data or with greater intervals. It is often possible to disable non-relevant sentences.
2. Set the operation mode of the multiplexer to Server mode (factory default). This mode only sends incoming data to the computer/PDA and to NMEA Out1, which is high speed. In Hub mode, the high speed ports must wait for every character to be transmitted over the low speed NMEA Out 2 port.

Both LED's will blink once when the power is applied to the MiniPlex-41BT. When the red LED stays lit, a hardware error is found during execution of the self-test.

Mounting

The MiniPlex-41BT is not waterproof. It should be mounted at a dry place, like behind the instrument panel, on a flat surface. Do not mount the MiniPlex-41BT in a metal enclosure or behind a metal panel, as this obstructs the radiowaves used for the Bluetooth connection.

Appendix A:

MPX-Config INI file format

The configuration file format of MPX-Config resembles the standard Windows INI file format. Below is an example with has all possible options listed. The example corresponds with the settings shown on the MPX-Config screenshot on page 5.

```
[Configuration]
Priority=0
Channel Numbers=0
Channel IDs=0
Mode=0
RealTime Ch.1=0
RealTime Ch.2=0
RealTime Ch.3=1
RealTime Ch.4=0
Talker ID1=II
Talker ID2=
Talker ID3=
Talker ID4=
[Filter]
HDT=00010
GGA=01100
GLL=01100
RMC=01100
GSA=01100
GSV=01100
```

The serial port settings of MPX-Config are not stored in the configuration file. They are stored in the Windows registry, using the following keys:

```
HKEY_CURRENT_USER\Software\CustomWare\MPXConfig\BaudRate
HKEY_CURRENT_USER\Software\CustomWare\MPXConfig\SerialPort
```

Appendix B:

MiniPlex-41BT Proprietary NMEA commands

The MiniPlex-41BT multiplexers support some NMEA commands through proprietary NMEA sentences. They also generate certain proprietary NMEA sentences in some modes of operation or as a response to NMEA commands.

All commands have the following format:

\$PSMDxx

\$P: Start of a proprietary command. Dictated by the NMEA standard.
SMD: ShipModul manufacturer's mnemonic.
xx: Two- or three-character command code.

For ease of manual configuration, the commands issued to the multiplexer do not require a checksum. Sentences output by the multiplexer always contain a checksum. Sentences output by the multiplexer always contain a checksum, denoted with *hh in the descriptions below.

Command reference

VER – Get Version

Retrieves version information from the multiplexer. The multiplexer responds with the following version sentence:

```
$PSMDVER,2.2.2,MiniPlex-41BT,50025943,0012*hh<CR><LF>
```

2.2.2: software version number
MiniPlex-41BT: product descriptor
50025943: serial number
0012: capabilities, used by MPXConfig to show the proper controls

CF – Configuration

This sentence sets the configuration of the multiplexer. The same sentence is sent by the multiplexer in response to a CFQ sentence.

Command: \$PSMDCF,b,m,s<CR><LF> or
\$PSMDCF,b,m,s*hh<CR><LF>

b: baudrate selector: 3 = 38400 baud (all other values are ignored)

m: mode selector: 0 = Server mode
1 = Hub mode
2 = Auto mode

s: Seataalk translation: 1 = on, 0 = off

When sending this command to the multiplexer, it is not necessary to specify every field when only one configuration parameter has to be changed. Fields preceding the one to be changed can be left blank. Fields after the one to be changed may be omitted. When for example only the mode must be changed, the command '\$PSMDCF,,1' may be sent. The field 'b' is left blank.

CFQ – Request current configuration

This sentence requests the current configuration settings from the multiplexer.

```
$PSMDCFQ<CR><LF>
```

The multiplexer responds with a CF sentence.
s. The multiplexer responds with an ID sentence.

OV – Overflow

In case of a buffer overflow (blinking red LED on the multiplexer), an overflow sentence is output, to indicate on which input buffer the overflow occurred. To conserve bandwidth, this sentence has no checksum.

```
$PSMDOV,x<CR><LF>
```

x: Binary field. The first four bits indicate on which input buffer the overflow occurred.

Declaration of Conformity

We,

CustomWare
Roggehullen 8
9403 WG Assen
The Netherlands
Tel.: +31 592 375700
Fax: +31 592 375550

Declare under our sole responsibility that the product

ShipModul MiniPlex-41BT

to which this declaration relates is in conformity with the following specifications:

EN/IEC61000-6-1:1997, EN/IEC61000-6-3:1996
EN 300328 and EN 301489
FCC Title 47 CFR, Part 15, FCC ID: PI4-TDK-BTISM

The product herewith complies with the requirements of the EMC Directive 89/336/EEC and carries the CE-marking accordingly.

Assen, 27-2-2004

M. Sprang

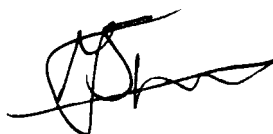

This device complies with Part 15 of the FCC Rules. Operation is subject to the following conditions:
(1) This device may not cause harmful interference, and (2) this device must accept any interference received, including interference that may cause undesired operation.

CE 0700 FC

ShipModul / CustomWare
Roggehullen 8
9403 WG Assen
The Netherlands

Tel.: +31 592 375700
Fax: +31 592 375550

web: www.shipmodul.com
e-mail: info@shipmodul.com